



**MAGNETROL®**

## TOP MOUNTING

Liquid Displacer Level Switches

### DESCRIPTION

Magnetrol's displacement type level switches offer the industrial user a wide choice of alarm and control configurations. Each unit utilizes a simple buoyancy principle and is well suited for simple or complex applications, such as foaming or surging liquids or agitated fluids, and usually costs less than other types of level switches.

### FEATURES

- Narrow or wide level ranges achieved through multiple switch mechanism capability
- Maximum process temperature: +260 °C (500 °F).
- Maximum process pressure: 55,1 bar (800 psi).
- S.G. as low as 0.4 kg/dm<sup>3</sup>.
- Displacers adjustable at any point along the suspension cable.
- Anti-surge design eliminates the possibility of switch short cycling.
- Standard 6 m (20 ft) of suspension cable, included for all models.
- Field adjustable set point and switch differential.
- Wide choice of displacer materials.
- Wide choice of housings and switch mechanisms
- Standard anti-corrosive protection.
- Proof-er® ground check
- Floating roof models
- NACE models
- Optional:
  - high temperature models
  - high pressure models
  - models for interface
  - suspension cable > 6m (20 ft)
  - special exterior surface preparation and finish.
- Suited for SIL 2 loops (DPDT switch)



### APPLICATIONS

- Foaming or surging liquids
- Agitated fluids
- Sewage handling
- Dirty liquids
- Paints
- Varnishes
- Heavy oils
- Liquids with solids

### Displacer level switches for single or multiple pump control/level alarm

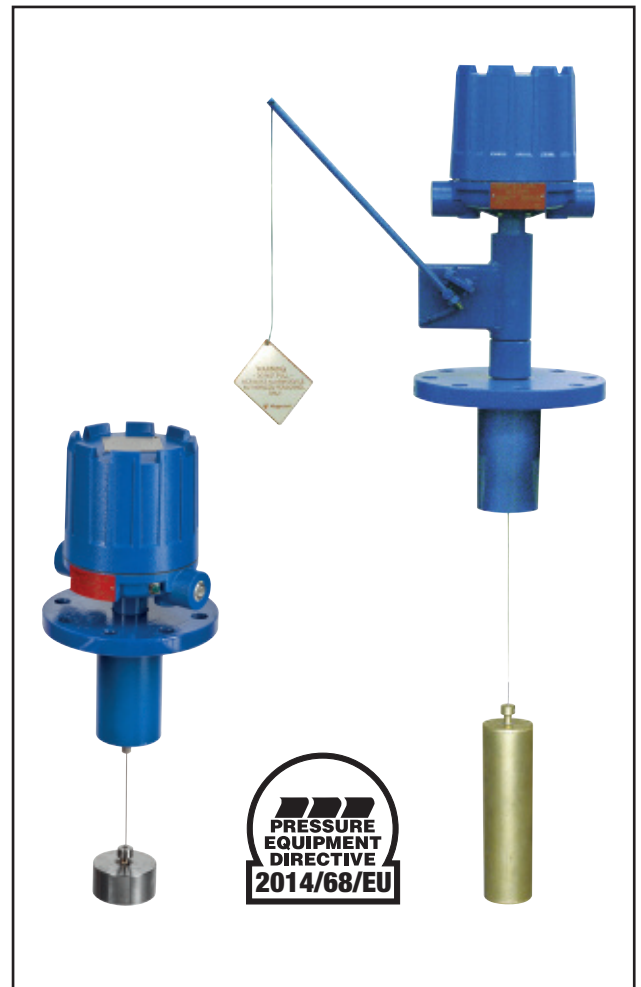

## PRINCIPLE OF OPERATION

### Standard controls

Operation is based upon simple buoyancy, whereby a spring is loaded with weighted displacers which are heavier than the liquid. Immersion of the displacers in the liquid results in buoyancy force change, which moves the spring upward. Since the spring moves only when the level moves on a displacer, spring movement (1) is always a small fraction of the level travel between displacers (2).

A magnetic sleeve (3) is connected to the spring and operates within a non-magnetic barrier tube (4). Spring movement causes the magnetic sleeve to attract a pivoted magnet (5), actuating a switch mechanism (6) located outside the barrier tube. Built-in limit stops, prevent over stroking of the spring under level surge conditions.

### Proof-er® controls

The purpose of the PROOF-ER is to check the operation of a displacer control without having to raise the level in the tank. This is accomplished by pulling downward on the PROOF-ER cable. A spring-loaded lever arm then lifts the switch actuator simulating a high or high-high level condition. When the cable is released, the PROOF-ER returns the actuator to its previous position to resume normal operation.

### Floating roof controls

The floating roof control is designed for installation on 'barrier' (floating roof) tanks. The control may be furnished with

a brass displacer to prevent sparking. A hollow brass displacer is required if the control is to actuate in liquid as well as by the barrier. A stainless steel displacer is also available. Consult factory for other options.

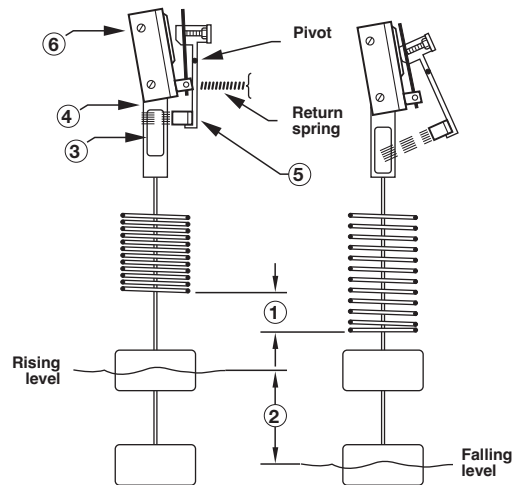

## MOUNTING



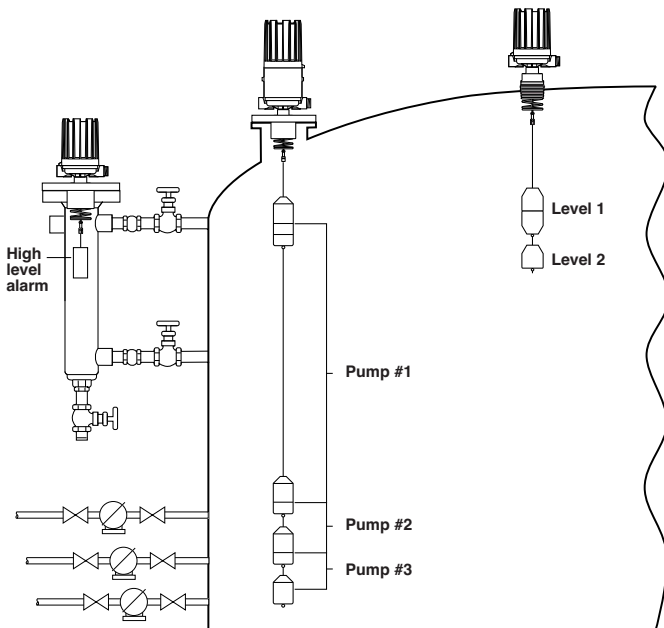

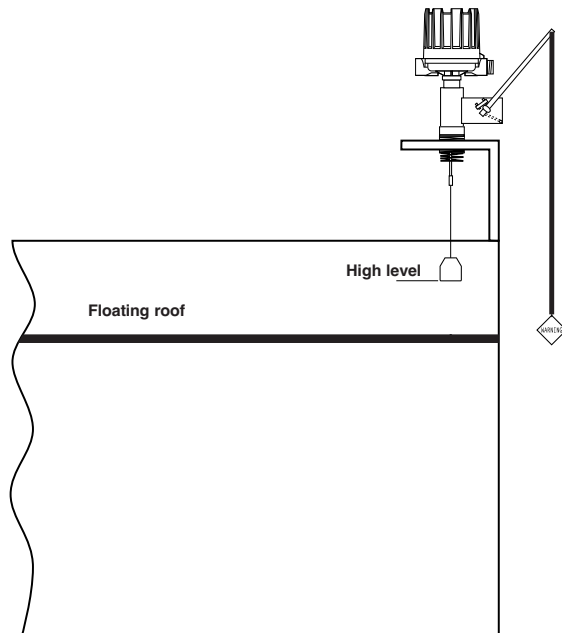

### Standard models



### Floating roof models (with Proof-er® as shown below)



## AGENCY APPROVALS

AGENCY	APPROVED MODEL	AREA CLASSIFICATION
<b>ATEX</b> 	All with electric switch mechanism and housing listed as ATEX Ex d	ATEX II 2 G Ex d IIC T6 Gb
	All with electric switch mechanism and housing listed as ATEX Ex ia	ATEX II 1 G EEx ia IIC T6
<b>FM</b> 	All with electric switch mechanism and housing listed as NEMA 7/9	Class I, Div 1, groups C & D Class II, Div 1, Groups E, F & G
	Consult factory for proper model numbers	Class I, Div 1, groups B, C & D Class II, Div 1, Groups E, F & G
<b>IECEX</b> 	All with electric switch mechanism and housing listed as ATEX Ex d	Ex d IIC T6 Gb
<b>CSA</b> 	Consult factory for proper model numbers	Class I, Div 1, groups C & D Class II, Div 1, Groups E, F & G
	Consult factory for proper model numbers	Class I, Div 1, groups B, C & D Class II, Div 1, Groups E, F & G
<b>EAC (Russia, Kazakhstan, Belarus)</b> 	All with electric switch mechanism and housing listed as ATEX Ex d	1Ex d IIC T6 Gb
	All with electric switch mechanism and housing listed as ATEX Ex ia	0Ex ia IIC T4 Ga
<b>LRS</b> 	Lloyds Register of Shipping	Marine approval
<b>CE</b> 	The units are conform to the ATEX directive 2014/34/EU, The PED directive 2014/68/EU and the Low Voltage Directive 2014/35/EU	
Other approvals are available, consult factory for more details		

## SELECTION DATA

Narrow Differential: for actuation of an alarm or system shutdown - up to 3 setpoints.

Wide Differential: switch differential for valve or pump control - up to 3 pump control functions.

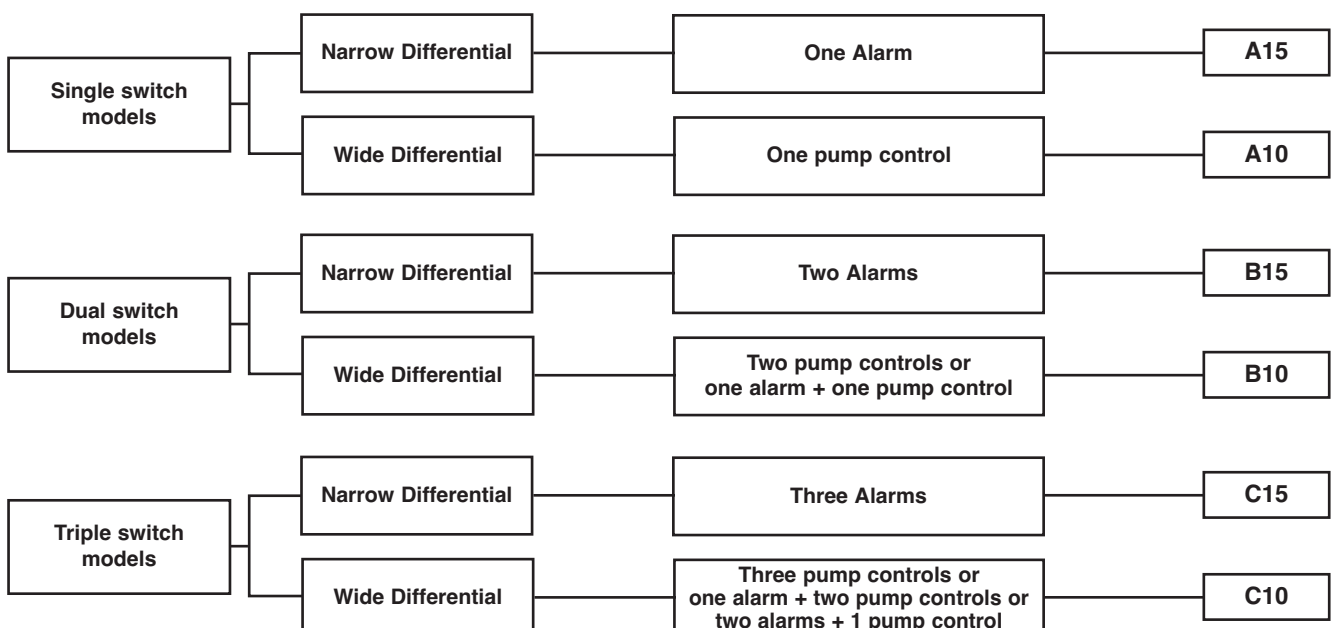

# SWITCH MODELS

## Single switch models

### Models A15 – Level alarm applications Narrow differential type

These instruments are factory calibrated to operate over a narrow level differential band and are ideally suited for liquid level alarm applications, on either high or low level.

The operating level is fully adjustable by simply repositioning the displacer along its suspension cable.

The differential band is  $\pm 51$  mm (2") in water and varies with liquid specific gravity.



### Models A10 – Pump or valve control Wide differential type

These wide differential units are factory calibrated to actuate as a liquid level reaches a given displacer and to deactivate when the level reaches a second displacer.

The minimum differential band is approximately 152 mm (6") in water and varies with liquid specific gravity. The maximum differential is determined by the length of the displacer suspension cable.



## Dual switch models

### Models B15 Narrow differential type

These instruments utilize two switches, each actuated at a different level and each calibrated with a narrow differential band.

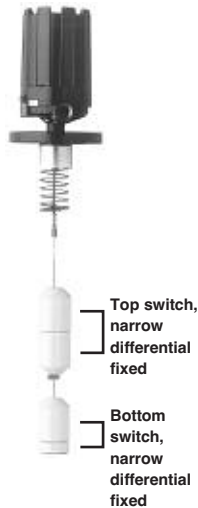

### Models B10 Wide differential type

These wide differential tandem units are factory calibrated with a choice of several operating sequences.



## Triple switch models

### Models C15 Narrow differential type

These instruments are factory calibrated to operate over a narrow level differential band while providing three electrically separate control signals in sequence as liquid level varies.



### Models C10 Wide differential type

These wide differential type switches are designed to provide three electrically separate control signals in sequence as liquid level varies.

These units are factory calibrated with a choice of several sequences combining wide and narrow level differential.



# SWITCH MECHANISMS AND HOUSINGS



## Series B, C, D, O, Q & U Dry contact switches ①

- Series B, C, O and Q switches are general purpose units with a selection of maximum liquid temperature ratings
- Series D switch is designed for high DC current applications
- Series U switches have gold alloy contacts



## Series HS ②, F, W, X & 8 Hermetically sealed switches

- Entire mechanism and contacts are contained within a positively pressurized capsule with series HS
- Ideal for use in salt and other corrosive atmospheres



## Series J & K Pneumatic switches ③

- Suited for process industry applications in hazardous locations or where electrical power is not available
- Series J bleed type switch is intended for general purpose applications
- Series K switch is specially designed to provide non-bleed operation with a high degree of vibration resistance



## Switch housings ④

- Die-cast aluminium housings
- Cast iron housings
- Stainless steel housings
- Optional housing heaters and drains available for some housings
- Pneumatic switch mechanisms available with alu base/cold rolled steel cover



## Series V Inductive Proximity switch ④

- Series V switches are inductive proximity switches type SJ3,5-SN with a maximum liquid temperature rating of +100 °C (+210 °F)

## Basic electrical ratings ①

Voltage	Switch Series and Non-Inductive Ampere Rating										
	B	C	D	F	HS	O	Q	U	W	X	8
120 V AC	15.00	15.00	10.00	2.50	5.00	15.00	15.00	1.00	1.00	0.50	1.00
240 V AC	15.00	15.00	—	—	5.00	15.00	15.00	—	1.00	0.50	—
24 V DC	6.00	6.00	10.00	4.00	5.00	6.00	6.00	1.00	3.00	0.50	3.00
120 V DC	0.50	1.00	10.00	0.30	0.50	1.00	0.50	—	0.50	0.50	—
240 V DC	0.25	0.50	3.00	—	0.25	0.50	0.25	—	—	—	—

For applications with heavy vibration, consult factory for suited switches.

① For more details see bulletin BE 42-683

② For more details on HS Hermetically sealed switches, see bulletin BE 42-694

③ For more details on J & K Pneumatic switches, see bulletin BE 42-685 and bulletin BE 42-686

④ For more details on V Inductive Proximity switches, see bulletin BE 42-798

## QUICK RESPONSE CELL (QRC)

Several models are available for extra quick shipment, within max. 15 days after factory receipt of purchase order, through the Quick Response Cell (QRC). To take advantage of QRC, simply match the green model number codes.

QRC delivery is limited to a maximum of 10 units per order. Contact your local representative for lead times on larger volume orders, as well as other products and options.

## EXPEDITE SHIP PLAN (ESP)

Several models are available for quick shipment, within max. 4 weeks after factory receipt of purchase order, through the Expedite Ship Plan (ESP). To take advantage of ESP, simply match the blue (or combination of green and blue) model number codes.

ESP delivery is limited to a maximum of 10 units per order. Contact your local representative for lead times on larger volume orders, as well as other products and options.

# SELECTION DATA SINGLE SWITCH MODEL

**A complete measuring system consists of:**

Order code for **standard** models (each unit is factory calibrated to operate on a given specific gravity within the min and the max values listed per model)

## PART NUMBER CODE AND SPECIFIC GRAFITY LIMITS

Part Number Code	Function	Liquid Temp.	Displacer Type	
		°C (°F)	Porcelain	Stainless Steel
A15	One adjustable set point (fixed narrow differential)	40 (100)	0.60 to 2.40	0.40 to 1.65
		95 (200)	0.62 to 2.40	0.40 to 1.65
		150 (300)	0.65 to 2.40	0.50 to 1.65
		200 (400)	0.70 to 2.40	0.55 to 1.65
		260 (500)	0.75 to 2.40	0.60 to 1.65
A10	One adjustable wide differential	40 (100)	0.60 to 1.20	0.60 to 1.20
		95 (200)	0.70 to 1.20	0.70 to 1.20
		150 (300)	0.80 to 1.20	0.80 to 1.20
		200 (400)	1.00 to 1.20	0.90 to 1.20
		260 (500)	1.10 to 1.20	1.00 to 1.20

MATERIALS OF CONSTRUCTION (6 m (20') of suspension cable is standard supplied)

Code	Spring	Trim	Process connections	Displacer clamps and cable	Magnetic sleeve	Construction
A	Inconel 600	316 SST (1.4401)	carbon steel	316 SST (1.4401)	400 series SST	Standard
B	Inconel 600	316 SST (1.4401)	carbon steel	316 SST (1.4401)	316 SST (1.4401)	Standard
D	Inconel 600	316 SST (1.4401)	316 SST (1.4401)	316 SST (1.4401)	316 SST (1.4401)	Standard
E	Inconel 600	316 SST (1.4401)	carbon steel	Monel (2.4360)	400 series SST	Standard
F	Inconel 600	316 SST (1.4401)	carbon steel	Hastelloy C (2.4819)	400 series SST	Standard
K	Inconel X750	316 SST (1.4401)	316 SST (1.4401)	316 SST (1.4401)	316 SST (1.4401)	NACE (not available with Proof-er® option)
L	Inconel X750	316 SST (1.4401)	carbon steel	316 SST (1.4401)	316 SST (1.4401)	NACE (not available with Proof-er® option)

### PROCESS CONNECTION

– threaded

E 2	2 1/2" NPT
-----	------------

– ASME flanges

G 3	3" 150 lbs ASME RF
G 4	3" 300 lbs ASME RF
G 5	3" 600 lbs ASME RF
H 3	4" 150 lbs ASME RF
H 4	4" 300 lbs ASME RF
H 5	4" 600 lbs ASME RF
K 3	6" 150 lbs ASME RF
K 4	6" 300 lbs ASME RF

– EN flanges

8 A	DN 80, PN 16	EN 1092-1 Type B1
8 B	DN 80, PN 25/40	EN 1092-1 Type B1
1 A	DN 100, PN 16	EN 1092-1 Type B1
1 B	DN 100, PN 25/40	EN 1092-1 Type B1

### DISPLACER MATERIAL AND PROOF-ER® OPTION

(for pressure ratings, refer to physical specifications table)

– without Proof-er®

can be used for NACE

A	Porcelain
B	316 SST (1.4401)

– with low pressure Proof-er®<sup>①</sup>

not for NACE

D	Porcelain
E	316 SST (1.4401)

– with medium pressure Proof-er®<sup>①</sup>

not for NACE

G	Porcelain
H	316 SST (1.4401)

<sup>①</sup> Proof-er® is available in carbon steel only

### SWITCH MECHANISM & HOUSING

Refer to table selections per displacer type models A15-A10 (next page)



complete order code for **standard** models

X = product with a specific customer requirement

SELECT ELECTRIC SWITCH MECHANISM & HOUSING: MODEL A15

Switch Description	Process ① Temperature Range °C (°F)	Contacts	Weather proof (IP 66)		ATEX (IP 66)						FM (IP 66)
					II 2G Ex d IIC T6 Gb				II 1G EEx ia IIC T6		NEMA 7/9
			Cast Aluminium		Cast Aluminium		Cast Iron		Cast Aluminium		Cast Alu.
			M20x1,5	1" NPT	M20x1,5	1" NPT	M20x1,5	¾" NPT	M20x1,5	1" NPT	1" NPT
Series B Snap switch	-40 to +120 (-40 to +250)	1x SPDT	B2Q	BAQ	BH9	BA9	BK5	BU5	–	–	BKQ
		1x DPDT	B8Q	BDQ	BJ9	BB9	BD5	BW5	–	–	BNQ
Series C Snap switch	-40 to +230 (-40 to +450)	1x SPDT	C2Q	CAQ	CH9	CA9	CK5	CU5	C2S	CAS	CKQ
		1x DPDT	C8Q	CDQ	CJ9	CB9	CD5	CW5	C8S	CDS	CNQ
Series D DC Current Snap switch	-40 to +120 (-40 to +250)	1x SPDT	D2Q	DAQ	DH9	DA9	DK5	DU5	–	–	DKQ
		1x DPDT	D8Q	DDQ	DJ9	DB9	DD5	DW5	–	–	DNQ
Series F Hermetically sealed Snap switch	-45 to +260 (-50 to +500)	1x SPDT	F2Q	FAQ	FH9	FA9	FK5	FU5	–	–	FKQ
		1x DPDT	F8Q	FDQ	FJ9	FB9	FD5	FW5	–	–	FNQ
Series HS Hermetically sealed Snap switch	-45 to +260 ② (-50 to +500)	1x SPDT	H7A	HM2	HFC	HA9	HB3	HB4	–	–	HM3
		1x DPDT	H7C	HM6	HGC	HB9	HB7	HB8	–	–	HM7
Series U Gold alloy contacts Snap switch	-40 to +120 (-40 to +250)	1x SPDT	U2Q	UAQ	UH9	UA9	UK5	UU5	U2S	UAS	UKQ
		1x DPDT	U8Q	UDQ	UJ9	UB9	UD5	UW5	U8S	UDS	UNQ
Series V Inductive Proximity switch	-40 to +100 (-40 to +210)	–	–	–	–	–	–	V5S	VBS	–	
Series W Hermetically sealed Silver plated contacts Snap switch	-45 to +230 (-50 to +450)	1x SPDT	W2Q	WAQ	WH9	WA9	WK5	WU5	W2S	WAS	WKQ
		1x DPDT	W8Q	WDQ	WJ9	WB9	WD5	WW5	W8S	WDS	WNQ
Series X Hermetically sealed Gold plated contacts Snap switch	-45 to +230 (-50 to +450)	1x SPDT	X2Q	XAQ	XH9	XA9	XK5	XU5	X2S	XAS	XKQ
		1x DPDT	X8Q	XDQ	XJ9	XB9	XD5	XW5	X8S	XDS	XNQ
Series 8 Hermetically sealed Snap switch	-45 to +260 (-50 to +500)	1x SPDT	82Q	8AQ	8H9	8A9	8K5	8U5	–	–	8KQ
		1x DPDT	88Q	8DQ	8J9	8B9	8D5	8W5	–	–	8NQ

SELECT ELECTRIC SWITCH MECHANISM & HOUSING: MODEL A10

Switch Description	Process ① Temperature Range °C (°F)	Contacts	Weather proof (IP 66)		ATEX (IP 66)						FM (IP 66)
					II 2G Ex d IIC T6 Gb				II 1G EEx ia IIC T6		NEMA 7/9
			Cast Aluminium		Cast Aluminium		Cast Iron		Cast Aluminium		Cast Alu.
			M20x1,5	1" NPT	M20x1,5	1" NPT	M20x1,5	¾" NPT	M20x1,5	1" NPT	1" NPT
Series B Snap switch	-40 to +120 (-40 to +250)	1x SPDT	B2B	BAB	BK9	BC9	BK5	BU5	–	–	BKB
		1x DPDT	B8B	BDB	BN9	BF9	BD5	BW5	–	–	BNB
Series C Snap switch	-40 to +230 (-40 to +450)	1x SPDT	C2B	CAB	CK9	CC9	CK5	CU5	C2T	CAT	CKB
		1x DPDT	C8B	CDB	CN9	CF9	CD5	CW5	C8T	CDT	CNB
Series D DC Current Snap switch	-40 to +120 (-40 to +250)	1x SPDT	D2B	DAB	DK9	DC9	DK5	DU5	–	–	DKB
		1x DPDT	D8B	DDB	DN9	DF9	DD5	DW5	–	–	DNB
Series F Hermetically sealed Snap switch	-45 to +260 (-50 to +500)	1x SPDT	FCB	FAB	FK9	FC9	FK5	FU5	–	–	FKB
		1x DPDT	FGB	FDB	FN9	FF9	FD5	FW5	–	–	FNB
Series HS Hermetically sealed Snap switch	-45 to +260 ② (-50 to +500)	1x SPDT	H7A	HM2	HFC	HA9	HB3	HB4	–	–	HM3
		1x DPDT	H7C	HM6	HGC	HB9	HB7	HB8	–	–	HM7
Series U Gold alloy contacts Snap switch	-40 to +120 (-40 to +250)	1x SPDT	U2B	UAB	UK9	UC9	UK5	UU5	U2T	UAT	UKB
		1x DPDT	U8B	UDB	UN9	UF9	UD5	UW5	U8T	UDT	UNB
Series V Inductive Proximity switch	-40 to +100 (-40 to +210)	–	–	–	–	–	–	VCS	VES	–	
Series W Hermetically sealed Silver plated contacts Snap switch	-45 to +230 (-50 to +450)	1x SPDT	W2B	WAB	WK9	WC9	WK5	WU5	W2T	WAT	WKB
		1x DPDT	W8B	WDB	WN9	WF9	WD5	WW5	W8T	WDT	WNB
Series X Hermetically sealed Gold plated contacts Snap switch	-45 to +230 (-50 to +450)	1x SPDT	X2B	XAB	XK9	XC9	XK5	XU5	X2T	XAT	XKB
		1x DPDT	X8B	XDB	XN9	XF9	XD5	XW5	X8T	XDT	XNB
Series 8 Hermetically sealed Snap switch	-45 to +260 (-50 to +500)	1x SPDT	82B	8AB	8K9	8C9	8K5	8U5	–	–	8KB
		1x DPDT	88B	8DB	8N9	8F9	8D5	8W5	–	–	8NB

SELECT PNEUMATIC SWITCH MECHANISM & HOUSING: MODEL A15 — MODEL A10 TYPE DISPLACER SWITCHES

Switch Description	Max supply pressure bar (psi)	Max process temperature ① °C (°F)	Bleed orifice ø mm (inches)	A15 codes	A10 codes
				NEMA 3R (IP 53)	NEMA 3R (IP 53)
Series J (open air)	6,9 (100)	200 (400)	1,60 (0.063)	JDE	JGF
	4,1 (60)	200 (400)	2,39 (0.094)	JEE	JHF
	4,1 (60)	260 (500)	1,40 (0.055)	JFE	JJF
Series K (closed circuit)	6,9 (100)	200 (400)	–	KOE	KOF

① Process temperature based on max. 40 °C (100 °F) ambient temperature and for non steam applications.

② On steam applications, temperature down-rated to +200 °C (+400 °F) process at +40 °C (+100 °F) ambient.

# SELECTION DATA DUAL SWITCH MODEL

## A complete measuring system consists of:

Order code for **standard** models (each unit is factory calibrated to operate on a given specific gravity within the min and the max values listed per model)

### PART NUMBER CODE AND SPECIFIC GRAVITY LIMITS

Part Number Code	Function	Liquid Temp.	Displacer Type	
		°C (°F)	Porcelain	Stainless Steel
B15	Two adjustable set points (fixed narrow differential)	40 (100)	0.95 to 1.20	0.70 to 1.20
		95 (200)	1.10 to 1.20	0.80 to 1.20
		150 (300)	-	0.90 to 1.20
		200 (400)	-	1.00 to 1.20
		260 (500)	-	1.04 to 1.20
B10 ①	Two adjustable wide differentials	40 (100)	0.60 to 1.20	0.50 to 1.00
		95 (200)	0.64 to 1.50	0.50 to 1.00
		150 (300)	0.80 to 1.50	0.60 to 1.00
		200 (400)	1.00 to 1.50	0.72 to 1.00
		260 (500)	1.10 to 1.50	0.84 to 1.00

① When ordering B10 units, an operating sequence and specific gravity must be provided.

MATERIALS OF CONSTRUCTION (6 m (20') of suspension cable is standard supplied)

Code	Spring	Trim	Process connections	Displacer clamps and cable	Magnetic sleeve	Construction
A	Inconel 600	316 SST (1.4401)	carbon steel	316 SST (1.4401)	400 series SST	Standard
B	Inconel 600	316 SST (1.4401)	carbon steel	316 SST (1.4401)	316 SST (1.4401)	Standard
D	Inconel 600	316 SST (1.4401)	316 SST (1.4401)	316 SST (1.4401)	316 SST (1.4401)	Standard
E	Inconel 600	316 SST (1.4401)	carbon steel	Monel (2.4360)	400 series SST	Standard
F	Inconel 600	316 SST (1.4401)	carbon steel	Hastelloy C (2.4819)	400 series SST	Standard
K	Inconel X750	316 SST (1.4401)	316 SST (1.4401)	316 SST (1.4401)	316 SST (1.4401)	NACE (not available with Proof-er® option)
L	Inconel X750	316 SST (1.4401)	carbon steel	316 SST (1.4401)	316 SST (1.4401)	NACE (not available with Proof-er® option)

### PROCESS CONNECTION – threaded

E 2	2 1/2" NPT
-----	------------

### – ASME flanges

G 3	3" 150 lbs ASME RF
G 4	3" 300 lbs ASME RF
G 5	3" 600 lbs ASME RF
H 3	4" 150 lbs ASME RF
H 4	4" 300 lbs ASME RF
H 5	4" 600 lbs ASME RF
K 3	6" 150 lbs ASME RF
K 4	6" 300 lbs ASME RF

### – EN flanges

8 A	DN 80, PN 16	EN 1092-1 Type B1
8 B	DN 80, PN 25/40	EN 1092-1 Type B1
1 A	DN 100, PN 16	EN 1092-1 Type B1
1 B	DN 100, PN 25/40	EN 1092-1 Type B1

### DISPLACER MATERIAL AND PROOF-ER® OPTION (for pressure ratings, refer to physical specifications table) – without Proof-er®

can be used for NACE

A	Porcelain
B	316 SST (1.4401)

### – with low pressure Proof-er® ①

not for NACE

D	Porcelain
E	316 SST (1.4401)

① Proof-er® is available in carbon steel only

### SWITCH MECHANISM & HOUSING

Refer to table selections per displacer type models B10-B15 (next page)



complete order code for **standard** models

X = product with a specific customer requirement



SELECT ELECTRIC SWITCH MECHANISM AND HOUSING: MODELS B10 & B15

Switch Description	Process ① Temperature Range °C (°F)	Contacts	Weather proof (IP 66)		ATEX (IP 66)						FM (IP 66)
					II 2G Ex d IIC T6 Gb				II 1G EEx ia IIC T6		NEMA 7/9
			Cast Aluminium		Cast Aluminium		Cast Iron		Cast Aluminium		Cast Alu.
			M20x1,5	1" NPT	M20x1,5	1" NPT	M20x1,5	¾" NPT	M20x1,5	1" NPT	1" NPT
Series B Snap switch	-40 to +120 (-40 to +250)	2x SPDT	B4B	BBB	BL9	BD9	BL5	BV5	–	–	BLB
		2x DPDT	B1B	BEB	BP9	BG9	BO5	BY5	–	–	BOB
Series C Snap switch	-40 to +230 (-40 to +450)	2x SPDT	C4B	CBB	CL9	CD9	CL5	CV5	C4T	CBT	CLB
		2x DPDT	C1B	CEB	CP9	CG9	CO5	CY5	C1T	CET	COB
Series D DC Current Snap switch	-40 to +120 (-40 to +250)	2x SPDT	D4B	DBB	DL9	DD9	DL5	DV5	–	–	DLB
		2x DPDT	D1B	DEB	DP9	DG9	DO5	DY5	–	–	DOB
Series F Hermetically sealed Snap switch	-45 to +260 (-50 to +500)	2x SPDT	FFB	FBB	FL9	FD9	FL5	FV5	–	–	FLB
		2x DPDT	FHB	FEB	FP9	FG9	FO5	FY5	–	–	FOB
Series U Gold alloy contacts Snap switch	-40 to +120 (-40 to +250)	2x SPDT	U4B	UBB	UL9	UD9	UL5	UV5	U4T	UBT	ULB
		2x DPDT	U1B	UEB	UP9	UG9	UO5	UY5	U1T	UET	UOB
Series W Hermetically sealed Silver plated contacts Snap switch	-45 to +230 (-50 to +450)	2x SPDT	W4B	WBB	WL9	WD9	WL5	WV5	W4T	WBT	WLB
		2x DPDT	W1B	WEB	WP9	WG9	WO5	WY5	W1T	WET	WOB
Series X Hermetically sealed Gold plated contacts Snap switch	-45 to +230 (-50 to +450)	2x SPDT	X4B	XBB	XL9	XD9	XL5	XV5	X4T	XBT	XLB
		2x DPDT	X1B	XEB	XP9	XG9	XO5	XY5	X1T	XET	XOB
Series 8 Hermetically sealed Snap switch	-45 to +260 (-50 to +500)	2x SPDT	84B	8BB	8L9	8D9	8L5	8V5	–	–	8LB
		2x DPDT	81B	8EB	8P9	8G9	8O5	8Y5	–	–	8OB

① Process temperature based on max. 40 °C (100 °F) ambient temperature and for non steam applications.

OPERATING SEQUENCES

Model B10 units are available factory calibrated with a choice of switch operating sequence. Five of the most popular sequences are described below.

**When ordering B10 units, an operating sequence and specific gravity must be provided.**

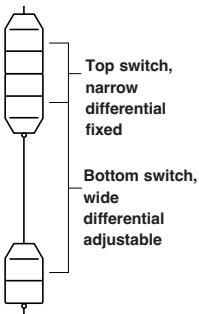

**PUMP CONTROL PLUS ALARM**  
**Arrangement N° 1 – fill with high level alarm**  
 At the lowest level the pump starts. When the level rises to the middle displacer, the pump stops. If the level continues to rise, the upper displacer actuates the alarm switch which remains actuated until the level drops to the middle displacer.

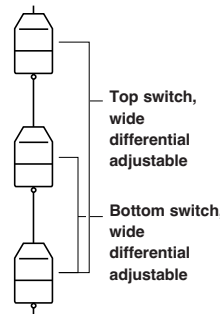

**CONTROL OF 2 PUMPS**  
**Arrangement N° 4 – drain**  
 In this sequence N° 1 pump starts as the level rises to the middle displacer. Should the level continue to rise to the upper displacer, N° 2 pump is actuated. Both pumps operate until the level is dropped to the lower displacer.

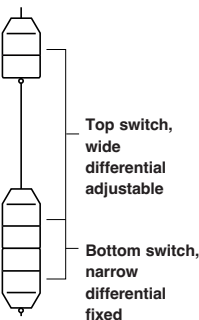

**Arrangement N° 2 – drain with low level alarm**  
 At the highest level, the pump starts. When the level falls to the middle displacer, the pump stops. If the level continues to fall, the lower displacer actuates the alarm switch which remains actuated until the level raises to the middle displacer.

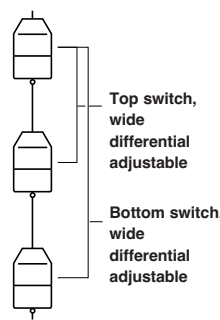

**Arrangement N° 5 – fill**  
 In this sequence N° 1 pump starts as the level falls to the middle displacer. Should the level continue to fall to the bottom displacer, N° 2 pump is actuated. Both pumps operate until the level is raised to the upper displacer.

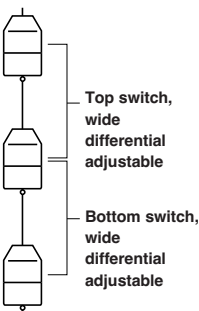

**CONTROL OF 2 PUMPS OF DIFFERENT CAPACITY**  
**Arrangement N° 3 – two switch, wide differential or drain**  
 The top switch cycles with level between the top and middle displacer. The bottom switch cycles with level between the middle and bottom displacer.

# SELECTION DATA TRIPLE SWITCH MODEL

Note: Each C10 and C15 instrument is factory calibrated to operate for a given specific gravity within the minimum and maximum values listed.

## PART NUMBER CODE AND SPECIFIC GRAVITY LIMITS

Part Number Code	Function	Liquid Temp.	Displacer Type	
		°C (°F)	Porcelain	Stainless Steel
C15 ①	Narrow differential, 3 switches	55 (130)	0.80 to 1.25	0.65 to 1.00
C10 ②	Wide differential, 3 switches	40 (100)	0.65 to 1.20	0.58 to 1.20
		95 (200)	0.95 to 1.10	0.76 to 1.00
		150 (300)	-	0.82 to 1.00

① When ordering C15 units, an operating specific gravity must be provided.

② When ordering C10 units, an operating sequence and operating specific gravity must be provided.

MATERIALS OF CONSTRUCTION (6 m (20') of suspension cable is standard supplied)

Code	Spring	Trim	Process connections	Displacer clamps and cable	Magnetic sleeve	Construction
A	Inconel 600	316 SST (1.4401)	carbon steel	316 SST (1.4401)	400 series SST	Standard
B	Inconel 600	316 SST (1.4401)	carbon steel	316 SST (1.4401)	316 SST (1.4401)	Standard
D	Inconel 600	316 SST (1.4401)	316 SST (1.4401)	316 SST (1.4401)	316 SST (1.4401)	Standard
E	Inconel 600	316 SST (1.4401)	carbon steel	Monel (2.4360)	400 series SST	Standard
F	Inconel 600	316 SST (1.4401)	carbon steel	Hastelloy C (2.4819)	400 series SST	Standard
K	Inconel X750	316 SST (1.4401)	316 SST (1.4401)	316 SST (1.4401)	316 SST (1.4401)	NACE (not available with Proof-er® option)
L	Inconel X750	316 SST (1.4401)	carbon steel	316 SST (1.4401)	316 SST (1.4401)	NACE (not available with Proof-er® option)

### PROCESS CONNECTION - threaded

E 2	2 1/2" NPT
-----	------------

- ASME flanges

G 3	3" 150 lbs ASME RF
G 4	3" 300 lbs ASME RF
G 5	3" 600 lbs ASME RF
H 3	4" 150 lbs ASME RF
H 4	4" 300 lbs ASME RF
H 5	4" 600 lbs ASME RF
K 3	6" 150 lbs ASME RF
K 4	6" 300 lbs ASME RF

- EN flanges

8 A	DN 80, PN 16	EN 1092-1 Type B1
8 B	DN 80, PN 25/40	EN 1092-1 Type B1
1 A	DN 100, PN 16	EN 1092-1 Type B1
1 B	DN 100, PN 25/40	EN 1092-1 Type B1

DISPLACER MATERIAL (proof-er® option not available)  
(for pressure ratings, refer to physical specifications table)  
- without Proof-er®

can be used for NACE

A	Porcelain
B	316 SST (1.4401)

### SWITCH MECHANISM & HOUSING

Switch Description	Process ① Temperature Range °C (°F)	Contacts	Weather proof (IP 66)		FM (IP 66)
			Cast Aluminium		NEMA 7/9
			M20 x 1,5	1" NPT	Cast Aluminium
Series O Snap Switch	-40 to +150 ② (-40 to +300)	3x SPDT	O6B	OCB	OMB
		3x DPDT	O1B	OEB	OKB
Series Q Snap Switch	-40 to +120 ② (-40 to +250)	3x SPDT	Q6B	QCB	QMB
		3x DPDT	Q1B	QEB	QKB

① Process temperature based on max. 40 °C (100 °F) ambient temperature and for non steam applications.  
② Model C15 limited to 55 °C (130 °F) max.



complete order code for **standard** models

X = product with a specific customer requirement

**OPERATING SEQUENCES**

**When ordering C15 units, a specific gravity MUST be provided.**

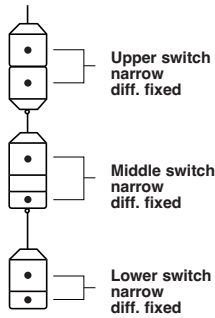

Model C10 units are available factory calibrated with a choice of switch operating sequence. Seven of the most popular sequences are described below.

**When ordering C10 units, an operating sequence and specific gravity MUST be provided.**

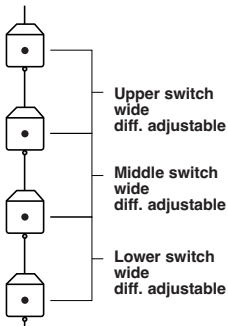

Arrangement A

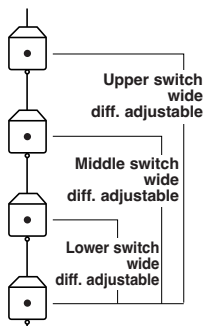

Arrangement B

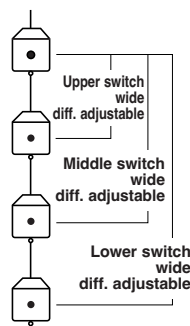

Arrangement C

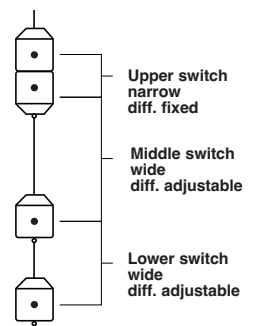

Arrangement D

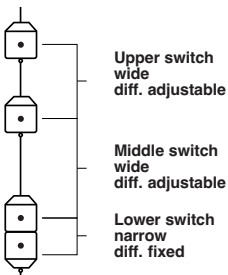

Arrangement E

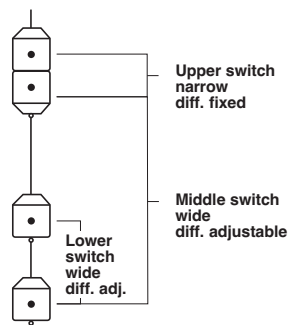

Arrangement F

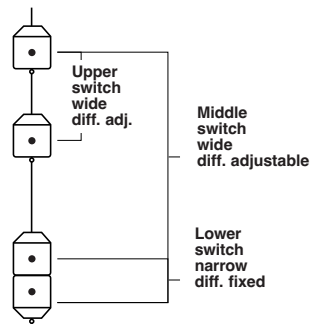

Arrangement G

# SELECTION DATA SINGLE SWITCH FLOATING ROOF MODEL

BASIC MODEL NUMBER – units for ALARM use ONLY

A	1	5	One adjustable set point (fixed narrow differential)
---	---	---	--

MATERIAL OF CONSTRUCTION (6 m (20') of suspension cable is standard supplied)

Code	Spring	Trim	Process connections	Displacer clamps and cable	Magnetic sleeve	Construction
A	Inconel 600	316 SST (1.4401)	carbon steel	316 SST (1.4401)	400 series SST	Standard
B	Inconel 600	316 SST (1.4401)	carbon steel	316 SST (1.4401)	316 SST (1.4401)	Standard
D	Inconel 600	316 SST (1.4401)	316 SST (1.4401)	316 SST (1.4401)	316 SST (1.4401)	Standard

PROCESS CONNECTION – size rating  
– threaded

E	2	2 1/2" NPT
---	---	------------

– ASME flanges

G	3	3" 150 lbs ASME RF
G	4	3" 300 lbs ASME RF
H	3	4" 150 lbs ASME RF
H	4	4" 300 lbs ASME RF
K	3	6" 150 lbs ASME RF
K	4	6" 300 lbs ASME RF

– EN flanges

8	A	DN 80, PN 16	EN 1092-1 Type B1
8	B	DN 80, PN 25/40	EN 1092-1 Type B1
1	A	DN 100, PN 16	EN 1092-1 Type B1
1	B	DN 100, PN 25/40	EN 1092-1 Type B1

DISPLACER MATERIAL AND PROOF-ER® OPTION (for pressure ratings, refer to physical specifications table)  
– without Proof-er®

P	Brass
R	Hollow brass (roof and liquid) <sup>①</sup>
M	Stainless steel

– with low pressure Proof-er®<sup>②</sup>

Q	Brass
T	Hollow brass (roof and liquid) <sup>①</sup>
N	Stainless steel

<sup>①</sup> Suitable for process liquids with SG ≥ 0.4.

<sup>②</sup> Proof-er® is available in carbon steel only.

SWITCH MECHANISM & HOUSING

Refer to table selections per displacer type model A15 (next page)

A	1	5							
---	---	---	--	--	--	--	--	--	--

complete order code for floating roof models

→ X = product with a specific customer requirement

SELECT ELECTRIC SWITCH MECHANISM & HOUSING: MODEL A15

Switch Description	Process ① Temperature Range °C (°F)	Contacts	Weather proof (IP 66)		ATEX (IP 66)						FM (IP 66)
					II 2G Ex d IIC T6 Gb				II 1G EEx ia IIC T6		NEMA 7/9
			Cast Aluminium		Cast Aluminium		Cast Iron		Cast Aluminium		Cast Alu.
			M20x1,5	1" NPT	M20x1,5	1" NPT	M20x1,5	¾" NPT	M20x1,5	1" NPT	1" NPT
Series B Snap switch	-40 to +120 (-40 to +250)	1x SPDT	B2Q	BAQ	BH9	BA9	BK5	BU5	–	–	BKQ
		1x DPDT	B8Q	BDQ	BJ9	BB9	BD5	BW5	–	–	BNQ
Series C Snap switch	-40 to +230 (-40 to +450)	1x SPDT	C2Q	CAQ	CH9	CA9	CK5	CU5	C2S	CAS	CKQ
		1x DPDT	C8Q	CDQ	CJ9	CB9	CD5	CW5	C8S	CDS	CNQ
Series D DC Current Snap switch	-40 to +120 (-40 to +250)	1x SPDT	D2Q	DAQ	DH9	DA9	DK5	DU5	–	–	DKQ
		1x DPDT	D8Q	DDQ	DJ9	DB9	DD5	DW5	–	–	DNQ
Series F Hermetically sealed Snap switch	-45 to +260 (-50 to +500)	1x SPDT	F2Q	FAQ	FH9	FA9	FK5	FU5	–	–	FKQ
		1x DPDT	F8Q	FDQ	FJ9	FB9	FD5	FW5	–	–	FNQ
Series HS Hermetically sealed Snap switch	-45 to +260 (-50 to +500)	1x SPDT	H7A	HM2	HFC	HA9	HB3	HB4	–	–	HM3
		1x DPDT	H7C	HM6	HGC	HB9	HB7	HB8	–	–	HM7
Series U Gold alloy contacts Snap switch	-40 to +120 (-40 to +250)	1x SPDT	U2Q	UAQ	UH9	UA9	UK5	UU5	U2S	UAS	UKQ
		1x DPDT	U8Q	UDQ	UJ9	UB9	UD5	UW5	U8S	UDS	UNQ
Series V Inductive Proximity switch	-40 to +100 (-40 to +210)	–	–	–	–	–	–	–	V5S	VBS	–
Series W Hermetically sealed Silver plated contacts Snap switch	-45 to +230 (-50 to +450)	1x SPDT	W2Q	WAQ	WH9	WA9	WK5	WU5	W2S	WAS	WKQ
		1x DPDT	W8Q	WDQ	WJ9	WB9	WD5	WW5	W8S	WDS	WNQ
Series X Hermetically sealed Gold plated contacts Snap switch	-45 to +230 (-50 to +450)	1x SPDT	X2Q	XAQ	XH9	XA9	XK5	XU5	X2S	XAS	XKQ
		1x DPDT	X8Q	XDQ	XJ9	XB9	XD5	XW5	X8S	XDS	XNQ
Series 8 Hermetically sealed Snap switch	-45 to +260 (-50 to +500)	1x SPDT	82Q	8AQ	8H9	8A9	8K5	8U5	–	–	8KQ
		1x DPDT	88Q	8DQ	8J9	8B9	8D5	8W5	–	–	8NQ

SELECT PNEUMATIC SWITCH MECHANISM & HOUSING: MODEL A15 TYPE DISPLACER SWITCHES

Switch Description	Max supply pressure bar (psi)	Max process temperature ① °C (°F)	Bleed orifice ø mm (inches)	A15 codes
				NEMA 3R (IP 53)
Series J (open air)	6,9 (100)	200 (400)	1,60 (0.063)	JDE
	4,1 (60)	200 (400)	2,39 (0.094)	JEE
	4,1 (60)	260 (500)	1,40 (0.055)	JFE
Series K (closed circuit)	6,9 (100)	200 (400)	–	KOE

① Process temperature based on max. 40 °C (100 °F) ambient temperature and for non steam applications.

# SELECTION DATA DUAL SWITCH FLOATING ROOF MODEL

BASIC MODEL NUMBER – units for ALARM use ONLY

B	1	5	Two adjustable set points (fixed narrow differentials)			
---	---	---	--	--	--	--

MATERIAL OF CONSTRUCTION (6 m (20') of suspension cable is standard supplied)

Code	Spring	Trim	Process connections	Displacer clamps and cable	Magnetic sleeve	Construction
A	Inconel 600	316 SST (1.4401)	carbon steel	316 SST (1.4401)	400 series SST	Standard
B	Inconel 600	316 SST (1.4401)	carbon steel	316 SST (1.4401)	316 SST (1.4401)	Standard
D	Inconel 600	316 SST (1.4401)	316 SST (1.4401)	316 SST (1.4401)	316 SST (1.4401)	Standard

PROCESS CONNECTION – size rating  
– threaded

E	2	2 1/2" NPT			
---	---	------------	--	--	--

– ASME flanges

G	3	3" 150 lbs ASME RF	
G	4	3" 300 lbs ASME RF	
H	3	4" 150 lbs ASME RF	
H	4	4" 300 lbs ASME RF	
K	3	6" 150 lbs ASME RF	
K	4	6" 300 lbs ASME RF	

– EN flanges

8	A	DN 80, PN 16	EN 1092-1 Type B1
8	B	DN 80, PN 25/40	EN 1092-1 Type B1
1	A	DN 100, PN 16	EN 1092-1 Type B1
1	B	DN 100, PN 25/40	EN 1092-1 Type B1

DISPLACER MATERIAL AND PROOF-ER® OPTION (for pressure ratings, refer to physical specifications table)  
– without Proof-er®

P	Brass
M	Stainless steel

– with low pressure Proof-er®<sup>①</sup>

Q	Brass
N	Stainless steel

<sup>①</sup> Proof-er® is available in carbon steel only

SWITCH MECHANISM & HOUSING

Refer to table selections per displacer type model B15 (next page)

B	1	5							
---	---	---	--	--	--	--	--	--	--

complete order code for floating roof models

→ X = product with a specific customer requirement

SELECT ELECTRIC SWITCH MECHANISM AND HOUSING: MODEL B15

Switch Description	Process ① Temperature Range °C (°F)	Contacts	Weather proof (IP 66)		ATEX (IP 66)						FM (IP 66)
					II 2G Ex d IIC T6 Gb				II 1G EEx ia IIC T6		NEMA 7/9
			Cast Aluminium		Cast Aluminium		Cast Iron		Cast Aluminium		Cast Alu.
			M20x1,5	1" NPT	M20x1,5	1" NPT	M20x1,5	¾" NPT	M20x1,5	1" NPT	1" NPT
Series <b>B</b> Snap switch	-40 to +120 (-40 to +250)	2x SPDT	B4B	BBB	BL9	BD9	BL5	BV5	–	–	BLB
		2x DPDT	B1B	BEB	BP9	BG9	BO5	BY5	–	–	BOB
Series <b>C</b> Snap switch	-40 to +230 (-40 to +450)	2x SPDT	C4B	CBB	CL9	CD9	CL5	CV5	C4T	CBT	CLB
		2x DPDT	C1B	CEB	CP9	CG9	CO5	CY5	C1T	CET	COB
Series <b>D</b> DC Current Snap switch	-40 to +120 (-40 to +250)	2x SPDT	D4B	DBB	DL9	DD9	DL5	DV5	–	–	DLB
		2x DPDT	D1B	DEB	DP9	DG9	DO5	DY5	–	–	DOB
Series <b>F</b> Hermetically sealed Snap switch	-45 to +260 (-50 to +500)	2x SPDT	FFB	FBB	FL9	FD9	FL5	FV5	–	–	FLB
		2x DPDT	FHB	FEB	FP9	FG9	FO5	FY5	–	–	FOB
Series <b>U</b> Gold alloy contacts Snap switch	-40 to +120 (-40 to +250)	2x SPDT	U4B	UBB	UL9	UD9	UL5	UV5	U4T	UBT	ULB
		2x DPDT	U1B	UEB	UP9	UG9	UO5	UY5	U1T	UET	UOB
Series <b>W</b> Hermetically sealed Silver plated contacts Snap switch	-45 to +230 (-50 to +450)	2x SPDT	W4B	WBB	WL9	WD9	WL5	WV5	W4T	WBT	WLB
		2x DPDT	W1B	WEB	WP9	WG9	WO5	WY5	W1T	WET	WOB
Series <b>X</b> Hermetically sealed Gold plated contacts Snap switch	-45 to +230 (-50 to +450)	2x SPDT	X4B	XBB	XL9	XD9	XL5	XV5	X4T	XBT	XLB
		2x DPDT	X1B	XEB	XP9	XG9	XO5	XY5	X1T	XET	XOB
Series <b>8</b> Hermetically sealed Snap switch	-45 to +260 (-50 to +500)	2x SPDT	84B	8BB	8L9	8D9	8L5	8V5	–	–	8LB
		2x DPDT	81B	8EB	8P9	8G9	8O5	8Y5	–	–	8OB

① Process temperature based on max. 40 °C (100 °F) ambient temperature and for non steam applications.

## PHYSICAL SPECIFICATIONS

Description		Specification
Measured variable		Liquid level
Physical range		Standard 6 m cable (field adjustable)
Process temperature Process pressure (for higher ratings consult factory)	Threaded models <sup>②</sup> Flanged models <sup>②</sup>	<u>Porcelain displacers:</u> <sup>①</sup> 55,1 bar @ 40 °C (800 psi @ 100 °F) – for threaded tank connections 260 °C @ 17,2 bar (500 °F @ 250 psi) – for threaded tank connections 96,5 bar @ 40 °C (1400 psi @ 100 °F) – for flanged 600 lbs rated tank connections <u>Stainless steel displacers:</u> 49,6 bar @ 40 °C (720 psi @ 100 °F) 260 °C @ 34,5 bar (500 °F @ 500 psi) Flanged models are downrated to the design pressure of the selected flange <u>Hollow brass displacers:</u> 6,9 bar @ 40 °C (100 psi @ 100 °F)
	Medium pressure Proof-er® models	8,6 bar @ 150 °C (125 psi @ 300 °F)
	Low pressure Proof-er® models	1,7 bar @ 90 °C (25 psi @ 200 °F)
Wetted materials	Spring	Inconel 600 or Inconel X750 (NACE)
	Displacer(s)	Porcelain <sup>①</sup> , 316 SST (1.4401) or brass
	Cable and clamps	316 SST (1.4401), Monel (2.4360) or Hastelloy C (2.4819)
Process connection material		Carbon steel or stainless steel

<sup>①</sup> Do not use porcelain displacers on non-vented boiler water condensate systems over 90 °C (200 °F).

<sup>②</sup> Cryogenic construction available upon request. Consult factory with application details.

## ELECTRICAL SPECIFICATIONS

Description	Specification
Switch ratings	Up to 15 A @ 240 V AC (depending on switch mechanism) Up to 10 A @ 120 V DC (depending on switch mechanism)
Signal output	Single, dual or triple SPDT or DPDT contacts or single pneumatic
Switch types (see table on page 5)	Dry contact with standard or gold alloy contacts, Hermetically sealed, Hermetically sealed with gold or silver plated contacts, Proximity switch, or single pneumatic bleed and non bleed

## ELECTRICAL CONNECTION

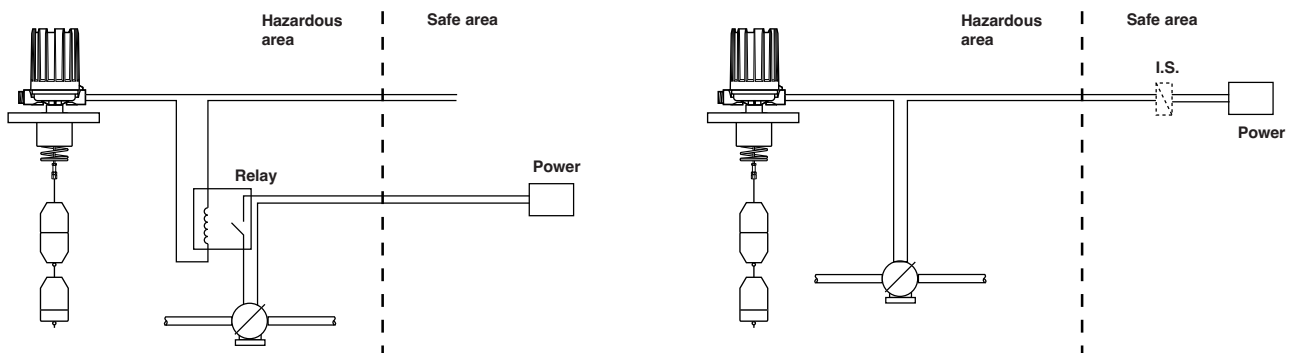



DIMENSIONS IN mm (inches) – housings

**Models A10/A15/B10/B15**  
Threaded mounting

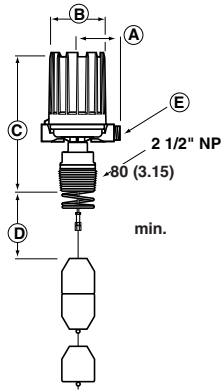

**Models A10/A15/B10/B15**  
Flanged mounting

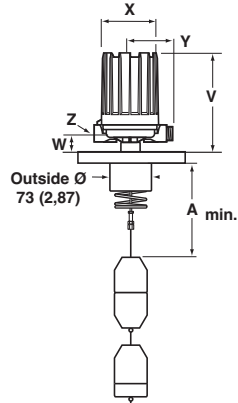

**Models C10/C15**  
Threaded mounting

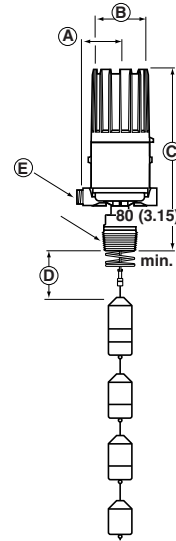

**Models C10/C15**  
Flanged mounting

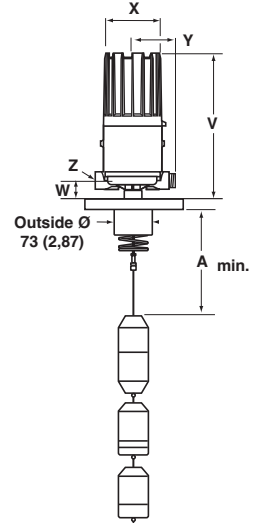

Housing type	Models	V	W	ø X	Y	Z
		mm (inches)	mm (inches)	mm (inches)	mm (inches)	
Weatherproof - FM (NEMA 7/9) - ATEX (Cast Alu)	A10	257 (10.12)	45 (1.77)	151 (5.93)	109 (4.29)	M20 x 1,5 (*) or 1" NPT (2 entries - 1 plugged)  (* not for FM (NEMA 7/9))
	A15 with HS-switch					
	B10					
	B15					
	A15 excl. HS-switch	202 ( 7.94)				
Weatherproof	C10 / C15	376 (14.81)				
ATEX (Cast Iron)	A10 / A15 / B10 / B15	249 ( 9.80)	45 (1.77)	143 (5.63)	110 (4.33)	M20 x 1,5 or 3/4" NPT (single entry - 2 entries at request)
Pneumatics Switch Module J	A10	216 ( 8.50)	39 (1.54)	118 (4.65)	110 (4.33)	1/4" NPT (1 entry)
	A15	165 ( 6.50)				
Pneumatics Switch Module K	A10	216 ( 8.50)			130 (5.12)	1/4" NPT (2 entries)
	A15	165 ( 6.50)				

Allow 200 mm (7.87") overhead clearance / All housings are 360 ° rotatable

Min. distance between mounting connection and top of displacer		A	
		Threaded	Flanged
Models	Displacer Type	mm (inches)	mm (inches)
A10	Porcelain	127 (5.00)	178 (7.00)
	Stainless steel	121 (4.75)	171 (6.75)
A15	Porcelain	143 (5.62)	194 (7.62)
	Stainless steel	143 (5.62)	194 (7.62)
B10	Porcelain	124 (4.88)	175 (6.88)
	Stainless steel	121 (4.75)	171 (6.75)
B15	Porcelain	140 (5.50)	191 (7.50)
	Stainless steel	149 (5.88)	200 (7.88)
C10	Porcelain	162 (6.38)	213 (8.38)
	Stainless steel	146 (5.75)	197 (7.75)
C15	Porcelain	197 (7.75)	248 (9.75)
	Stainless steel	184 (7.25)	235 (9.25)

# DIMENSIONS IN mm (inches) – displacers

## Models A10/A15/B10/B15 - Standard models

	A10	A15	B10	B15
Porcelain				
Stainless steel				

## Models C10 & C15 - Standard models

	C10 operating sequence	C15 operating sequence
Porcelain	<p><b>Arrangements</b> (see page 11)</p> <p>(A) 163 (6.42)    (B) 127 (5.00)    (C) 92 (3.62)    (D) 291 (11.44)    (E) 219 (8.64)</p> <p><b>Note:</b> All displacers <math>\varnothing</math> 65 (2.56).</p>	<p><math>\varnothing</math> 65 (2.56)</p>
Stainless steel	<p><b>Arrangements</b> (see page 11)</p> <p>(F) 152 (6.00)    (G) 114 (4.50)    (H) 305 (12.00)    (J) 229 (9.00)</p> <p><b>Note:</b> All displacers <math>\varnothing</math> 64 (2.50).</p>	<p><math>\varnothing</math> 64 (2.50)</p>

DIMENSIONS IN mm (inches) – displacers

Models A15/B15 - Floating roof models

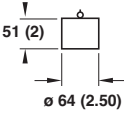
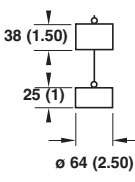
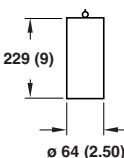
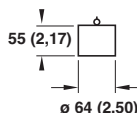
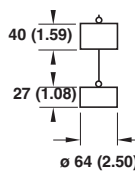
	A15	B15
Brass		
Hollow Brass		not applicable
Stainless steel		

DIMENSIONS IN mm (inches) – Proof-er®

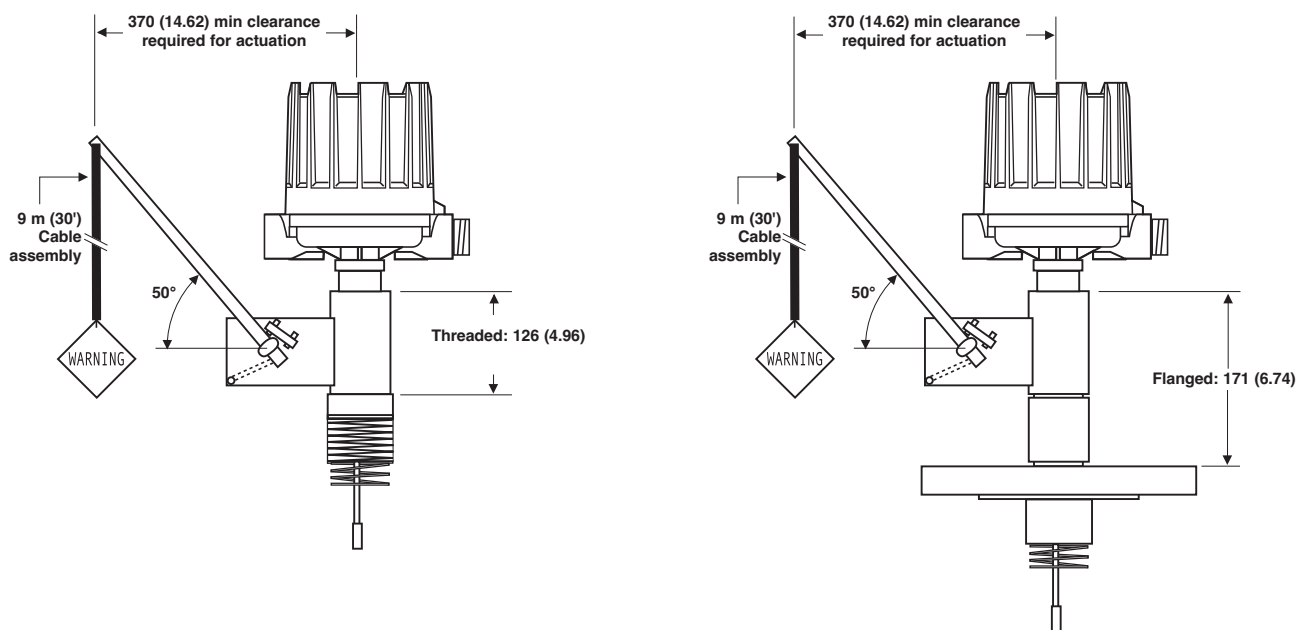



#### QUALITY ASSURANCE - ISO 9001

THE QUALITY ASSURANCE SYSTEM IN PLACE AT MAGNETROL GUARANTEES THE HIGHEST LEVEL OF QUALITY DURING THE DESIGN, THE CONSTRUCTION AND THE SERVICE OF CONTROLS. OUR QUALITY ASSURANCE SYSTEM IS APPROVED AND CERTIFIED TO **ISO 9001** AND OUR TOTAL COMPANY IS COMMITTED TO PROVIDING FULL CUSTOMER SATISFACTION BOTH IN QUALITY PRODUCTS AND QUALITY SERVICE.

#### PRODUCT WARRANTY

ALL MAGNETROL MECHANICAL LEVEL CONTROLS ARE WARRANTED FREE OF DEFECTS IN MATERIALS AND WORKMANSHIP FOR FIVE FULL YEARS FROM THE DATE OF ORIGINAL FACTORY SHIPMENT.

IF RETURNED WITHIN THE WARRANTY PERIOD; AND, UPON FACTORY INSPECTION OF THE CONTROL, THE CAUSE OF THE CLAIM IS DETERMINED TO BE COVERED UNDER THE WARRANTY; THEN, MAGNETROL INTERNATIONAL WILL REPAIR OR REPLACE THE CONTROL AT NO COST TO THE PURCHASER (OR OWNER) OTHER THAN TRANSPORTATION.

MAGNETROL SHALL NOT BE LIABLE FOR MISAPPLICATION, LABOR CLAIMS, DIRECT OR CONSEQUENTIAL DAMAGE OR EXPENSE ARISING FROM THE INSTALLATION OR USE OF THE EQUIPMENT. THERE ARE NO OTHER WARRANTIES EXPRESSED OR IMPLIED, EXCEPT, SPECIAL WRITTEN WARRANTIES COVERING SOME MAGNETROL PRODUCTS.

BULLETIN: BE 45-115.14  
EFFECTIVE: APRIL 2018  
SUPERSEDES: October 2017

UNDER RESERVE OF MODIFICATIONS

### European Headquarters & Manufacturing Facility

Heikensstraat 6

9240 Zele, Belgium

Tel: +32-(0)52-45.11.11 • Fax: +32-(0)52-45.09.93

e-mail: [info@magnetrol.be](mailto:info@magnetrol.be)

[www.magnetrol.com](http://www.magnetrol.com)

