

Table of contents

	Page
Overview	P2

Specification / application	P3

NB 4000	P4

Options / Accessories	P6

Dimensions / materials	P7

Spare parts	P9

Electrical installation	P11

Subject to change.

All dimensions in mm (inches).

All prices in Euro, excluding VAT.

All prices are EXW Betzigau, excluding packaging costs.

Valid: From 01.04.2013 until 31.03.2014, unless otherwise agreed.

By publishing this selection list all other lists become invalid.

We assume no liability for typing errors.

Different variations to those specified are possible.
Please contact our technical consultants.

Overview

Features

Continuous level measurement of solids applications

Process

- Independent of bulk material properties
- Accurate measurement

Service

- Simple installation and commissioning
- Rope and tape version with long service life
- Low maintenance

Approvals

- Approval for use in Hazardous Areas

Mechanics

- Measurement range up to 30m (100ft)
- 1 1/2" process connection possible
- Aiming flange to be mounted directly on a flat silo roof
- Internal tape cleaner for difficult materials

Electronics

- Micro processor controlled measurement
- Diagnostic possibilities
- Output 4-20mA
- Two programmable Relay (can be used as Counting pulse output or as Failure / Upper stop position)



NB 4100
Rope version
Fig. with flange DN 100
and PVC sensor weight



NB 4200
Tape version
Fig. with thread connection
and stainless steel sensor
weight



NB 4100
Rope version
Fig. with aiming flange and
stainless steel sensor weight
with pin

Specification / application

Specification

Process	Measurement range	15m (50ft) or 30m (100ft)
	Process temperature	80°C (176°F)
	Process overpressure	-0,2 .. +0,2 bar (-3.0 .. + 3.0 psi)
	Min. powder density	>300 g/l (18 lb/ft³)
Electronics	Power supply	AC version 115V or 230V 50-60Hz DC version 20 .. 28V
	Output	4-20mA
		2 relais (optional)
Certificate	Dust Ex	ATEX 1/2D FM Cl. II, III Div. 1
	General purpose	CE, FM
		Metrological certification (Belarus)

Application

Solids measurement

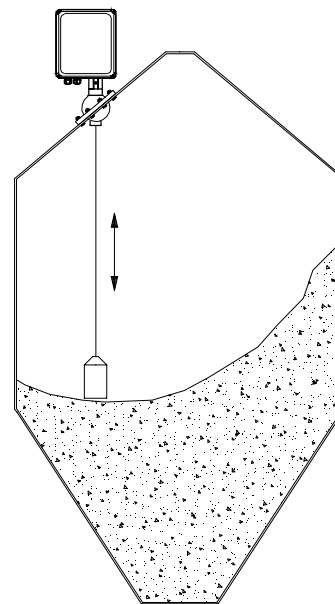
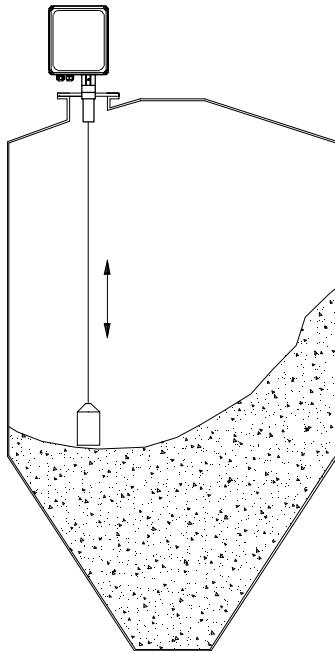

Aiming flange
screwed directly
to the silo roof

NB 4000

NB 4100

Rope version
(fig. with flange DN 100
and PVC sensor weight)



NB 4200

Tape version
(fig. with thread connection
and stainless steel sensor
weight)



Cable entries (by default)

Depending on selected version (options see pos. 26):

CE, ATEX Screwed cable gland: 1x M25x1.5 and 1x M20x1.5
Blindplug: 1x M20x1.5

FM Open conduit ANSI B1.20.1: 1x NPT 3/4" and 1x NPT 1/2"
Blindplug: 1x NPT 1/2"

Dimensions see page P7

NB 4000

- pos. 1 **Basic type**
 C **NB 4100** Rope version
 D **NB 4200** Tape version

 pos. 2 **Certificate**
 O CE
 W ATEX II 1/2 D
 M FM general purpose
 N FM Class II, III Div.1 Group E-G

 pos. 3 **Measurement range**
 1 15m (50ft)
 2 30m (100ft)

 pos. 4 **Power supply**
 1 230V 50-60Hz
 2 115V 50-60Hz
 3 20 .. 28V DC

 pos. 5 **Process connection**
 A Thread R 1 1/2 inch tapered DIN 2999
 B Thread NPT 1 1/2 inch tapered ANSI B1.20.1
 X Flange DN100 PN16 (EN1092-1) and flange 4" 150lbs ANSI B16.5 (unit is fitting to this flange)
 Y Flange 2" and flange 3" 150lbs ANSI B16.5 (unit is fitting to this flange)
 W Aiming flange (to be mounted directly to the silo roof) ⁽⁴⁾
- pos. 6 **Sensor weight ⁽¹⁾**
 Y without ⁽²⁾
 A PVC ⁽³⁾
 C Stainless steel
 E Folding cover

Basic type

NB 4..00						
Position	1	2	3	4	5	6

← **Order code**

All positions are available in special design (use code "Z").

- ⁽¹⁾ For use in Hazardous Locations (Dust Ex): It must be ensured, that no static discharge from the material surface can occur. Sensor weights, which can be used in case of possible static discharge, on request.
- ⁽²⁾ Only for tape version. Including mounting set for sensor weight (see page P9: Sensor weights)
- ⁽³⁾ Does not fit through a 1 1/2 inch nozzle, must be mounted after fixing the unit to the silo
- ⁽⁴⁾ Mounting without a socket. Including fixing material (screws, sealing etc.)

Options / Accessories

Options

- pos. 21 **Weather protection cover**
 For Ex only approved for Zone 22 or Division 2
- pos. 22 **Internal heater**
 Needed for: ambient temp. <-20°C (-4°F) or condense water inside silo or wet process atmosphere
 (Note: <-20°C (-4°F) with ATEX or FM Class II on request possible)
- pos. 23 **Length of socket pipe**
 1 200mm (7.87")
 2 500mm (19.7")
 3 1000mm (39.4")
- pos. 24 **Pin for sensor weight**
 POM or stainless steel (in accordance to selected sensor weight material, not for pos.6 E)
- pos. 25 **Relais output**
 Two relais (selectable as "Counting pulse output" or as "Failure"/"Upper stop position")
- pos. 26 **Cable entry**
 Selection of the following options only necessary, if a deviation from the default cable gland / conduit is required:
 0 Screwed cable gland 1x M25x1,5 + 1x M20x1,5 + blindplug 1x M20x1,5
 A Conduit 1x NPT 3/4"+ 1x NPT 1/2" + blindplug 1x NPT 1/2"

Accessories

Fixing material for mounting the unit on a flange

zu107000 4 bolts M16x60, 8 washers, 4 nuts. Stainless steel.

Sealings for mounting the unit on a flange

di300125 Flange sealing for DN100 PN16 / 4" (neoprene)
 di300127 Flange sealing for 2" / 3" 150lbs (neoprene)

Adapter NPT 1 1/2" to NPT 3"

zu103100 Thread tapered ANSI B1.20.1, aluminium

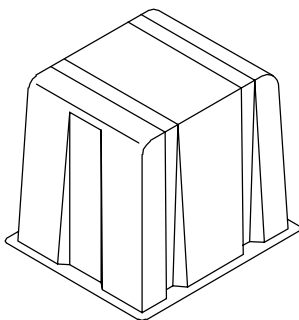

Weather protection cover

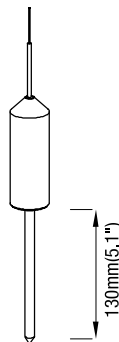

Pin for sensor weight
 POM or 1.4305 (303)

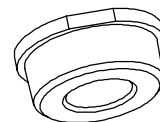

Adapter NPT 1 1/2" to NPT 3"

Dimensions and materials

Basic unit

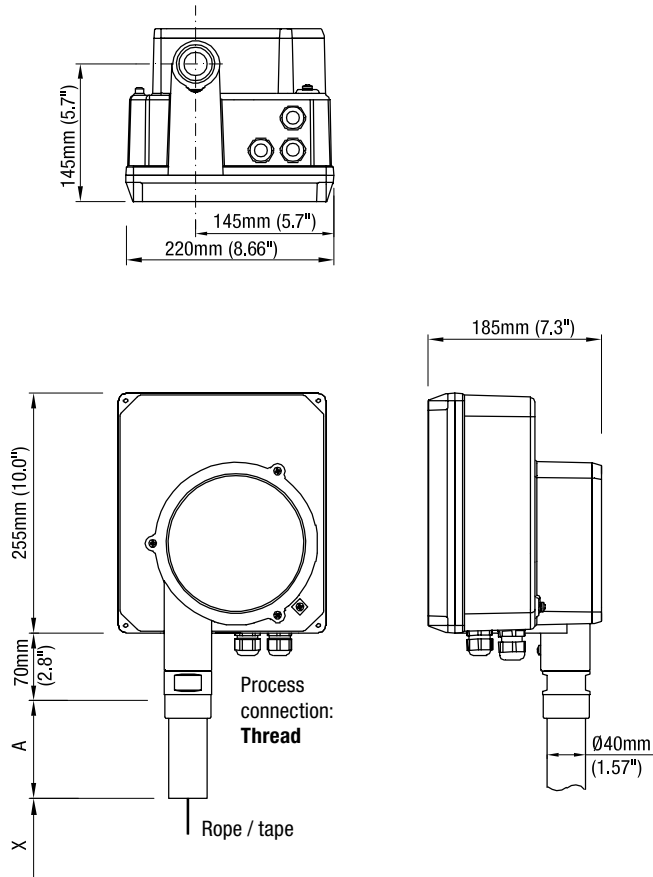

Process connection: **Flange**

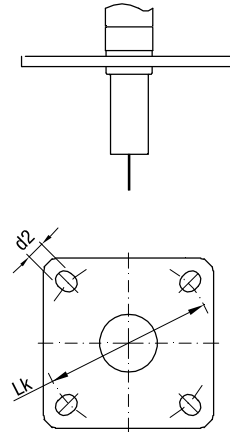

Process connection: **Aiming flange**

To be screwed directly to the silo roof
 0°-50° adjustable
 Including screws, nuts and sealing

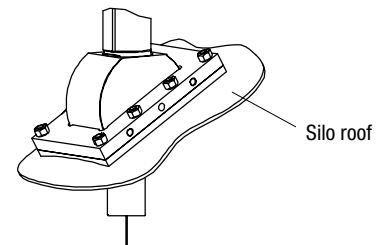

Flange plate outside dimensions:
 Width x Height: 120mm x 180mm (4.7"x7.1")

Dimensions

X = Length to bottom of sensor weight (in upper stop position, see next page)	
A = Length of socket pipe 100mm (3.9") Optional 200mm (7.9") / 500mm (19.7") / 1000mm (39.4")	
Flanges	
fitting to: DN100 PN16 / 4" 150lbs	Lk = Ø180-190.5mm (7.1-7.5") slot d2 = Ø19mm (0.75")
fitting to: 2" / 3" 150lbs	Lk = Ø120.7-152.4mm (4.75-6.0") slot d2 = Ø19mm (0.75")
Rope	Ø1,25mm (0.49")
Tape	12x0.2mm (0.47x0.008")

Materials

Housing outside	Aluminium, powder coated
Housing inside	Aluminium
Thread / Flange	Aluminium
Aiming flange	Aluminium / 1.4301 (301)
Rope	1.4301 (304)
Tape	1.4310 (301)

Dimensions and materials

Sensor weights

Rope version

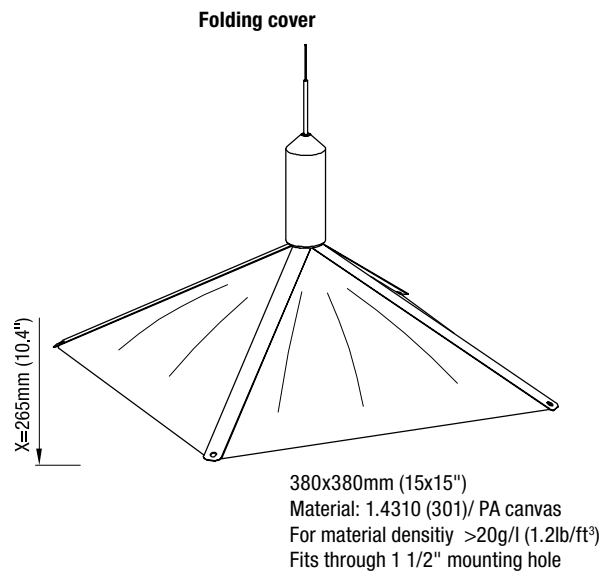
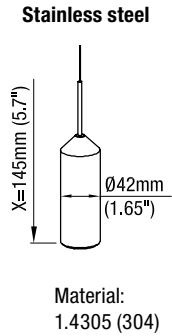
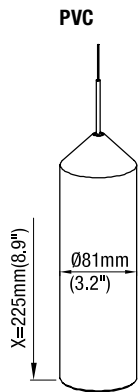

All sensor weights:
1,6 kg (3.5 lbs)

Tape version

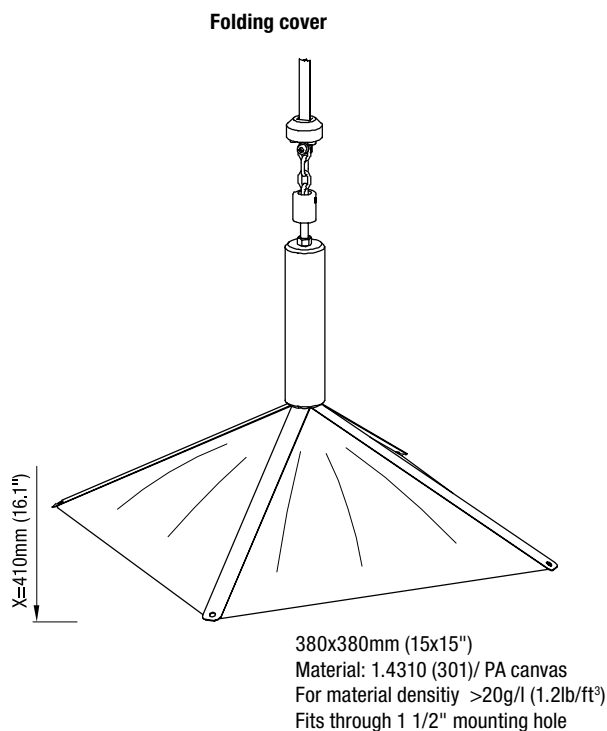
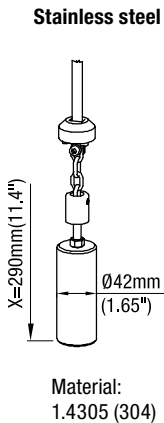
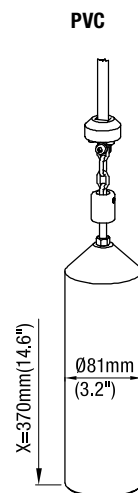

Fixing elements between tape and sensor
weight: aluminium / 1.4305 (304)

All sensor weights:
1,6 kg (3.5 lbs)

Spare parts

Roller

sl103239	Rope roller with 15m rope
sl103240	Rope roller with 30m rope
sb103239	Tape roller with 15m tape
sb103240	Tape roller with 30m tape

Sensor weights

All sensor weights are delivered incl. mounting set for proper fixing to the rope/tape and excl. rope/tape

For rope version:

sl103231	PVC without pin
sl103232	PVC with pin
sl103233	Stainless steel without pin
sl103234	Stainless steel with pin
sl103235	Folding cover

For tape version:

sb103231	PVC without pin
sb103232	PVC with pin
sb103233	Stainless steel without pin
sb103234	Stainless steel with pin
sb103235	Folding cover

Motor

gm103202	Motor
-----------------	-------------

Electronics

pl103690	230V 50-60Hz	4-20mA	without 2 Relais and without Internal Heater Control
pl103691	230V 50-60Hz	4-20mA	with 2 Relais and with Internal Heater Control ⁽¹⁾
pl103692	115V 50-60Hz	4-20mA	without 2 Relais and without Internal Heater Control
pl103693	115V 50-60Hz	4-20mA	with 2 Relais and with Internal Heater Control ⁽¹⁾
pl103694	20 .. 28V DC	4-20mA	without 2 Relais and without Internal Heater Control
pl103695	20 .. 28V DC	4-20mA	with 2 Relais and with Internal Heater Control ⁽¹⁾

Required information: Rope or Tape version; measuring range 15m or 30m; evt. further menue presettings.

Internal Heater ⁽²⁾

em100373	680 Ohms	For power supply 230V 50-60Hz
em100374	220 Ohms	For power supply 115V 50-60Hz
em100375	8,2 Ohms	For power supply 20 .. 28V DC

Weather protection cover

zu400217
-----------------	-------

⁽¹⁾ Implements the electronic components needed to control the Internal Heater (needed for option pos.22)

⁽²⁾ Used for replacement for already mounted heater.

In case of re-fitting the Internal Heater, the electronics must include components for the Internal Heater Control (please contact factory).

Spare parts

Sensor weights

All sensor weights are delivered including stated parts for proper fixing to the rope / tape

Rope version

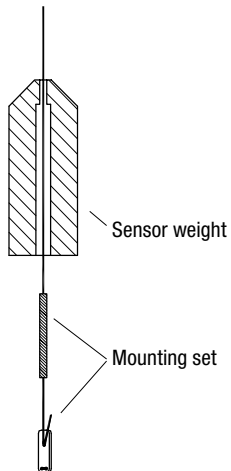

Tape version

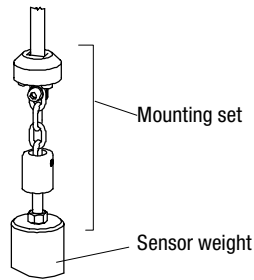

Electronics

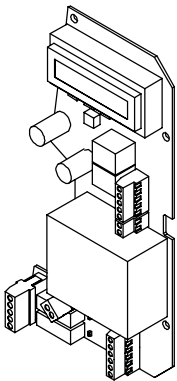

Motor

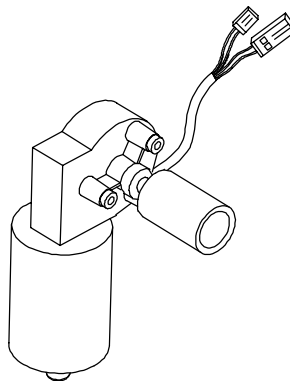

Internal heater

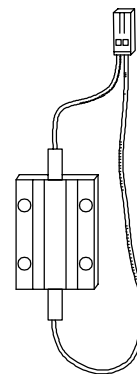

Weather protection cover

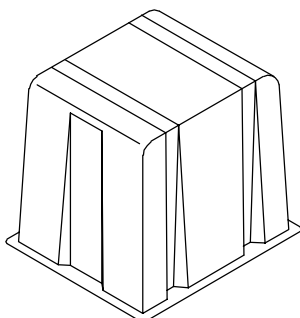

Electrical installation

Power supply

AC version

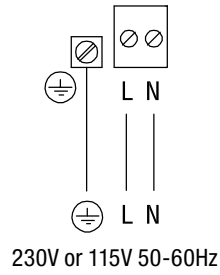

AC or DC supply
 depending on
 ordered version

DC version

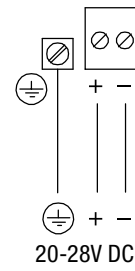

Signal input: Start of measurement

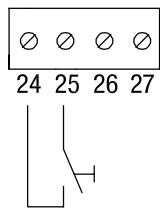

Start contact

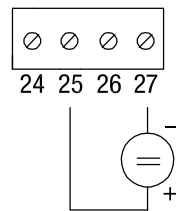

Start +24V

alternative

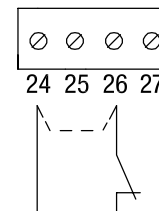

Measurement interruption in
 case of filling. If used, remove
 factory provided connection.

Signal output: 0/4-20mA

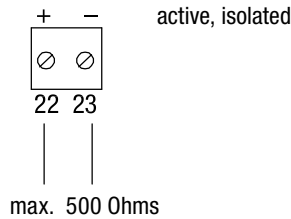

Signal output: Relais (optional)

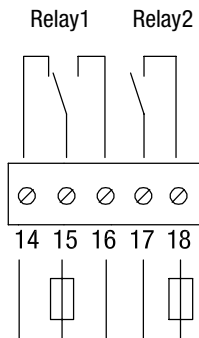

Fuse: max. 2A
 max. 250V AC, 2A, 500VA, non inductive