

Magnetic level gauge PN 40/CL 300

Magnetic indicating bar scale with fine resolution, indirect level indication
Fully closed housing with gapless weldings and butt-welded connections
Float magnet field totally circular with strong far field
Float defect control with indicating field in lower display end

Product group **710**

Type **110.0**

Sheet: 1/2

Revision: 9

Date:

11/08



Typ 110.0 e. g. equipped with magnetic switch type 740.0066 and indicator 710.AVG3

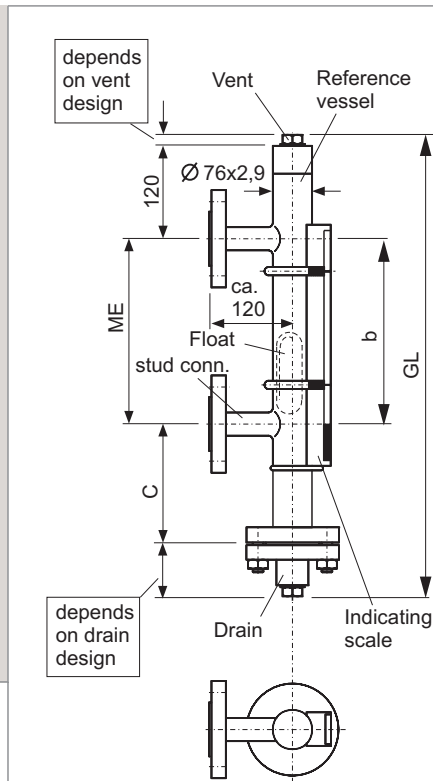

Field of Application

The magnetic level gauge is for indicating the level of low density liquids in any vessel via bypass. Simultaneously you can use level switches (740) or level sensors (745) mounted onto the reference vessel tube to signalling level limits or measure the level height by remote means.

General Data

Density, float Titanium: from 0,29 g/cm³
Precision for Interface or density: from ±0,01 g/cm³
Measuring range (=ME): single piece up to 5000 mm, above split construction, from 3000 mm holding bracket each 1500 mm
Measuring error: ±10 mm
Viscosity: max 1000 mPas
Display type: 710.AVG3
Connection: weld end (Standard), Flanges DIN and ANSI
Drain/vent: Cap (Standard), plug 1/2" NPT, as option 3/4" NPT, G1/2A, G3/4A Valve DN6, optional DN8, Flange stud DIN and ANSI and acc. to customer spec.
Material tube, stud, 1.4571 (Standard), ANSI-coded flanges, fixtures: Titanium, Hastelloy, etc., float: Titanium etc.
Weight: Basic 14 kg + 0,66 kg/100mm ME

Derating-Diagram

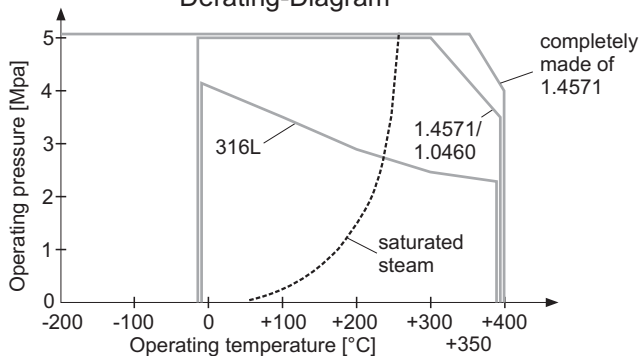

Design Data

Operating pressure: up to 5,2 MPa/300 lbs (see Derating-Diagram)
Temperature Media
Reference vessel cpl. 1.4571: -200 ... +400 °C
flanges 1.0460: -10 ... +400 °C (see Derating-Diagram)
Below -10 °C Indicating scale .AVG2 and below -20 °C add frost protection with 710.ISOL
In both cases preparation for insulation included.

Certificates

Pressure Vessel Directive (PED) 97/23/EG
EC-Type Examination Certificate: TÜV 03 ATEX 2190
Zone 0
Subject to alterations

Ordering no.

710.110.0 - XXX - XXXX - XXXXXXXX

Density, e.g.
054=0,54 g/cm³

Center to center ME
in mm

Connections etc.
see sheet
710.VAR

PHÖNIX

Messtechnik GmbH
Salzschlirfer Straße 13
D-60386 Frankfurt/M.
Tel. +49/69/41 67 42 -20
Fax +49/69/41 67 42 -29
sales@phoenix-mt.com
www.phoenix-mt.com

PHÖNIX

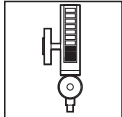

Details

Float, Vent, Drain and Connection

Product group **710**

Type **110.0**

Sheet: 2/2

Revision: 9

Date:

11/08

Float material Titanium, Ø56, PN40/CL300

Density range [g/cm ³]	Measure C [mm]	Total length L [mm]	Weight [g]	Part no
0,72 ... 0,67	209	210	235	BG1001109072
0,66 ... 0,58	249	250	260	BG1001109066
0,58 ... 0,54	289	290	290	BG1001109058
0,53 ... 0,51	339	340	327	BG1001109053
0,50 ... 0,49	369	370	352	BG1001109050
0,48 ... 0,46	419	420	388	BG1001109048
0,45 ... 0,44	479	480	431	BG1001109045
0,43 ... 0,40	579	580	505	BG1001109043
0,39 ... 0,37	699	700	590	BG1001109039
Interface float (individually designed ±0.01 g/cm ³)				BG1001109TRX

Density range corresponds to measuring error ±10 mm

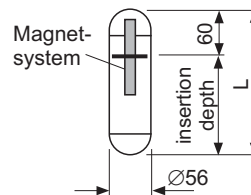

Vent

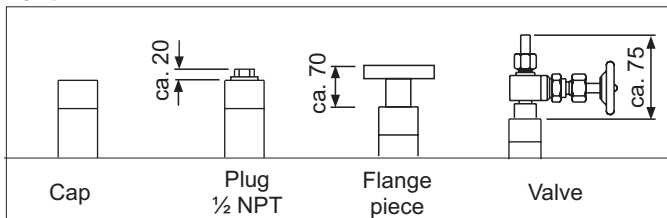

Drain

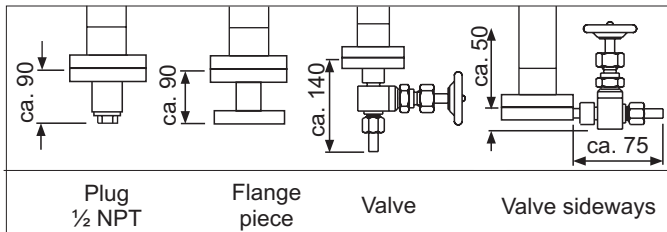

Design Data

Operating pressure: up to 5,2 MPa/300 lbs
(see Derating-Diagram for 1.4571)
Test pressure: Operating pressure x 1,3
Operating temperature: -200 ... +400 °C
(see Derating-Diagram for 1.4571)

Subject to alterations

Connections

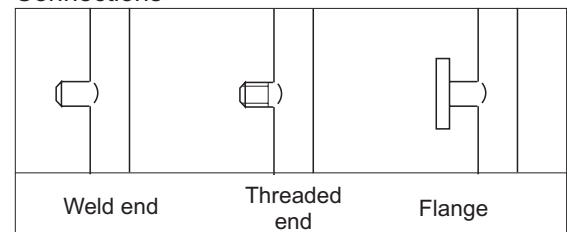

Ordering no.

Accessories:

Device	Product group
Magnetic switch	740.XXXX
Level sensor	745.XXXX
Indicating scale	710.AVGX
Frost protection	710.PLEXI
Heating	710.HEAT

Spare parts:

Designation	Part no.
Float	s. Float table above
Indicating scale	710.AVGX
Sealing	0690077005VG
Fixing springs	3813000672
Align magnet	BG10XXXXMAKU

There may be any other customer specified connections, materials and special floats.

PHÖNIX

Messtechnik GmbH
Salzschlirfer Straße 13
D-60386 Frankfurt/M.
Tel. +49/69/41 67 42 -20
Fax +49/69/41 67 42 - 29
sales@phoenix-mt.com
www.phoenix-mt.com

PHÖNIX